



# AV-30-E

## Installation Manual



© 2020 uAvionix Corporation. All rights reserved.

Except as expressly provided herein, no part of this guide may be reproduced, transmitted, disseminated, downloaded or stored in any storage medium, for any purpose without the express written permission of uAvionix. uAvionix grants permissions to download a single copy of this guide onto an electronic storage medium to be viewed for personal use, provided that the complete text of this copyright notice is retained. Unauthorized commercial distribution of this manual or any revision hereto is strictly prohibited.

uAvionix® and Ping® are registered trademarks of uAvionix Corporation and may not be used without express permission of uAvionix.

AV-30, AV-30-E, and AV-30-C are trademarks of uAvionix Corporation and may not be used without express permission of uAvionix.

Patent [uavionix.com/patents](http://uavionix.com/patents)

# 1 Revision History

Revision	Date	Comments
A	6/2/2020	Initial release

## 2 Warnings / Disclaimers

All device operational procedures must be learned on the ground.

uAvionix is not liable for damages arising from the use or misuse of this product.

This equipment is classified by the United States Department of Commerce's Bureau of Industry and Security (BIS) as Export Control Classification Number (ECCN) 7A994.

These items are controlled by the U.S. Government and authorized for export only to the country of ultimate destination for use by the ultimate consignee or end-user(s) herein identified. They may not be resold, transferred, or otherwise disposed of, to any other country or to any person other than the authorized ultimate consignee or end-user(s), either in their original form or after being incorporated into other items, without first obtaining approval from the U.S. government or as otherwise authorized by U.S. law and regulations.

### 3 Table of Contents

1	Revision History .....	3
2	Warnings / Disclaimers .....	4
3	Table of Contents .....	5
4	AV-30-E System Information .....	7
4.1	System Description .....	7
4.2	System Functions .....	9
4.3	System Specifications.....	10
5	Design Standards .....	11
5.1	Applicable Performance Standards .....	12
6	Installation Locations & Operating Modes.....	13
6.1	Installation Locations .....	13
6.2	Operating Mode Configuration .....	13
7	Functionality and Required Interfaces.....	14
7.1	Aircraft Systems Connections .....	14
7.2	Feature Matrix.....	15
7.2.1	Power Input (Required).....	16
7.2.2	Pitot and Static Interfaces (Required/Optional) .....	16
7.2.3	Outside Air Temp Input (Optional).....	16
7.2.4	Audio Output (Optional) .....	17
7.2.5	GPS Interface (Optional) .....	17
7.2.6	tailBeaconX Control (optional).....	18
7.3	Internal Battery Operation .....	18
7.3.1	General .....	18
8	Equipment Installation .....	19
8.1	Overview .....	19
8.2	Supplied Components .....	19
8.3	Non-Supplied Components .....	19
8.4	Mechanical Drawing .....	20
8.5	Mounting Screw Length Restriction.....	21
8.6	Wiring Diagrams .....	22
8.7	Bonding Requirements .....	24
8.8	Unit Pinout .....	25
9	Setup & Configuration .....	26
9.1	Startup and Common Controls.....	26
9.2	Available Menus .....	27
9.3	Install Menu Activation.....	28

9.4	Install Menu Settings .....	29
9.5	Mandatory Settings.....	30
9.5.1	Unit Function.....	30
9.5.2	Function Lock.....	30
9.5.3	Trims .....	30
9.5.4	V-Speeds .....	30
9.5.5	Display Units .....	30
9.5.6	Serial Inputs .....	31
9.5.7	Demo Mode .....	31
9.6	System Checkout.....	31
9.6.1	Alignment .....	31
9.6.2	OAT Interface.....	32
9.6.3	GPS Navigator Interface .....	32
9.6.4	tailBeaconX control Interface.....	33
10	Troubleshooting .....	34
11	Serial Interface Specification .....	35
12	Field Update Capability.....	36

## 4 AV-30-E System Information

### 4.1 System Description

The uAvionix AV-30-E is a fully digital multi-mode instrument that mounts in the legacy 3 1/8" round instrument panel. It can be field configured as either an Attitude Indicator (AI) or a Directional Gyro (DG) indicator. It is fully self-contained with dual-precision inertial and pressure sensors and allows for a wide variety of pilot customization.



*Figure 1 - AV-30-E Multi Mode AI/DG – Basic Display*

When configured as an AI, primary attitude and slip are always displayed. The un-used portions of the display area can be customized by the pilot to show a variety of textual and graphical data-overlay fields. Three pages may be customized by the pilot while a fourth page presents a fully decluttered view of only attitude and slip.

When configured as a Directional Gyro (DG), direction of flight information is presented. The flight direction can be configured to be presented as non-slaved heading or inertially stabilized GPS track when connected to an external GPS navigator. Multiple display presentations, including compass rose, GPS HSI, and GPS Arc views can be selected by the pilot. The un-used portions of the display area can similarly be configured for a variety of textual data-overlays.

In both operating modes, the pilot may select from multiple visual styles which are intended to improve visual compatibility with legacy aircraft instrumentation and preserve the look-and-feel of older aircraft applications.

A wide variety of supplemental functions, including audio alerting, derived angle of attack presentation, g-load display, and more are provided. An internal, rechargeable LiPo battery allows for operation for a nominal 2 hours in the event of aircraft power loss and 30 minutes minimum under all temperature conditions.



## 4.2 System Functions

### Primary Functions:

- Primary Attitude (AI Mode)
- Primary Slip (AI Mode)
- Primary Direction of Flight Indication (DG Mode)

### Supplemental Functions:

- Indicated Airspeed
- Altitude
- V-Speeds
- Angle of Attack
- Vertical Trend
- Vertical Speed
- Set Altitude
- Heading
- Bus Voltage
- G Load
- Outside Air Temp
- True Airspeed
- Density Altitude
- GPS Navigator / Waypoint Data
- GPS Navigator Nav Data
- GPS Navigator Route Line
- Heading Bug

### Audio and Visual Alerting Functions:

- AoA Alerting
- G Limit Alerting
- Excessive Roll Alerting

### Misc. Functions:

- Internal Battery Operation
- Auto / Manual Brightness

## 4.3 System Specifications

<b>Electrical Attributes</b>	
Input Voltage Nominal	+10 to +32 VDC
Input Voltage Max	+60 VDC
Input Power Nominal	6 Watts (0.5 Amps @ 12VDC)
Input Power Max	12 Watts (1.0 Amps @ 12VDC)
Required Circuit Breaker	2 Amp
Operation on Battery	2 Hrs Typ @ 20°C / 30 Min Minimum @ -20C
<b>Physical Attributes</b>	
Mounting Configuration	3 1/8" Round Instrument Hole
Dimensions wo/Connector	3.38 x 3.38 x 1.6 Inches
Weight	0.56 Lbs.
Electrical Connector	15 Pin Male D-Sub
Pneumatic Connectors	1/4" OD Quick Connect
Mounting	(4X) #6-32 Machine Screws
Case Material	Billet Aluminum
<b>Environmental</b>	
Ground Survival Low	-55°C
Operating Low	-20°C
Ground Survival High	+85°C
Operating High	+55°C
Altitude	25,000 Feet Max
<b>Optical Characteristics</b>	
Diagonal Size	3" Circular
Contrast Ratio (Typical)	500
Brightness (Typical)	1000 cd/m <sup>2</sup>
Viewing Angle Left/Right	60°
Viewing Angle Up	45°
Viewing Angle Down	10°
Backlight Lifetime (Typical)	50,000 Hrs

*Table 1 - System Specifications*

## 5 Design Standards

This installation manual provides mechanical and electrical information necessary to install the AV-30-E. The content of this manual assumes use by competent and qualified personnel using standard maintenance procedures in accordance with Title 14 of the Code of Federal Regulation (CFR) and other related accepted procedures.

The design basis for the AV-30-E is 14 CFR Part 23, Amendment 23-61. Installation is approved as a Level A system and is robust to High Intensity Radiated Field (HIRF) and lightning levels applicable for both metallic and non-metallic aircraft.



The installer must ensure that all installation limitations as defined in this document are observed.

The internal battery capacity has been tested and verified to provide 30 minutes of operational capacity (with reserve), and meets the requirements defined in CFR 23.1311(a)(5) and 23.1353(h), allowing independent operation from the primary electrical power system.

See *Section 7.3 Internal Battery Operation* for additional battery operational characteristics.

## 5.1 Applicable Performance Standards

The AV-30-E was designed to, and satisfied the applicable performance requirements defined in the following design standards:

<b>MOPS</b>	<b>Title</b>	<b>Category</b>
SAE AS8019	Airspeed Instruments	Type B
SAE AS392C	Altimeter, Pressure Actuated, Sensitive Type	Type I
SAE AS8005A	Standard Temperature Instruments	Class IIIc
SAE AS8034	Airborne Multipurpose Electronic Displays	N/A
RTCA DO-334	Attitude and Heading Reference Systems (AHRS)	A5 H9 T7
ASTM F3011-13	Angle Of Attack System	N/A
RTCA DO-347	Cert and Test for Small and Med Lipo Batteries	Medium Size

*Table 2 - Applicable Performance Standards*

## 6 Installation Locations & Operating Modes

### 6.1 Installation Locations

The following figure shows a typical “six-pack” and one possible arrangement of instrument locations:

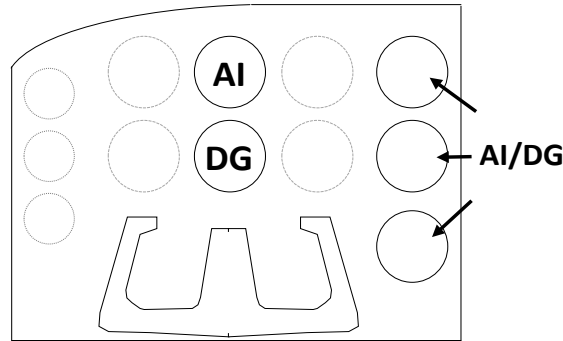

*Figure 2 – Mechanical Gauge Replacement*

Note that the physical arrangement in many aircraft varies from the traditional “T” configuration shown above. The AI/DG locations are examples of installation locations as a non-required instrument.

 The existing mechanically based altimeter and airspeed indicator must remain in their factory locations for this installation configuration.

### 6.2 Operating Mode Configuration

The AV-30-E operating mode is configured during installation and can be set as follows:

- Unit locked as a dedicated Attitude Indicator (AI Mode)
- Unit locked as a dedicated Direction Indicator (DG Mode)
- Unit can be toggled between AI and DG mode by the pilot

If the functionality is not locked, pressing and holding the rotary knob will toggle between AI and DG mode.

# 7 Functionality and Required Interfaces

## 7.1 Aircraft Systems Connections

All aircraft systems connections are provided on the single 15-Pin D-sub connector and two quick-connect pneumatic fittings. Various interfaces are optional as indicated in the following diagrams.

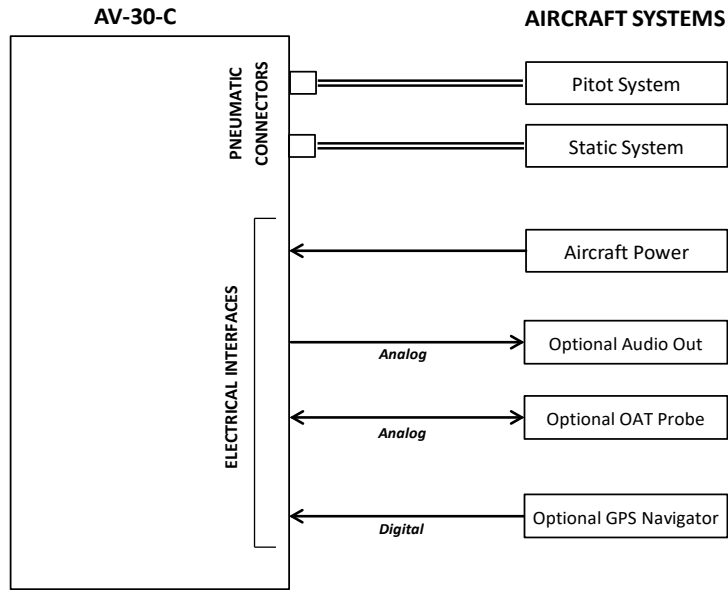

Figure 3 – AV-30-E Aircraft Systems Interfaces – AI Mode

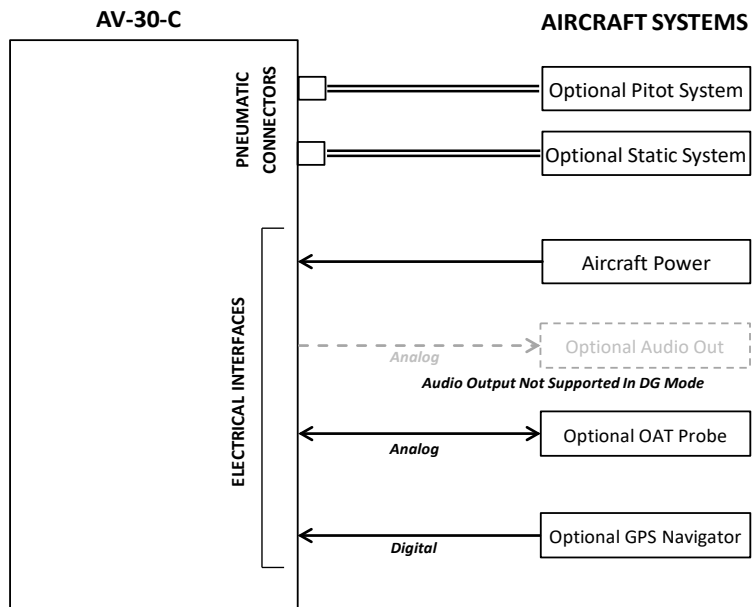

Figure 4 – AV-30-E Aircraft Systems Interfaces – DG Mode

## 7.2 Feature Matrix

The following matrix shows primary and supplemental data and any required external interface.

Feature	AI Mode	DG Mode	Required Interface
<b>Primary Attitude and Slip</b>			
Primary Attitude	✓	✗	None
Primary Slip	✓	✗	None
Reversionary Attitude / Slip	✗	✓	None
<b>Primary Direction of Flight Indication</b>			
Direction Tape (DG / GPS)	✓	✗	None / GPS Navigator
Direction Rose (DG)	✗	✓	None
Direction Arc (GPS)	✗	✓	GPS Navigator
Direction HSI (GPS)	✗	✓	GPS Navigator
<b>Supplemental Data Overlays – Pilot Configurable (Textual or Graphical)</b>			
Indicated Airspeed (Textual)	✓	✗	Pitot / Static
V-Speeds (Graphical)	✓	✗	Pitot / Static
Baro Altitude (Textual)	✓	✗	Pitot / Static
Angle Of Attack (Graphical)	✓	✗	Pitot / Static
Vertical Trend (Graphical)	✓	✗	Pitot / Static
Vertical Speed (Textual)	✓	✗	Pitot / Static
Set Altitude (Textual)	✓	✗	None
Heading (Textual)	✓	✓	None
Bus Voltage (Textual)	✓	✓	None
G Load (Textual)	✓	✓	None
Outside Air Temp (Textual)	✓	✓	OAT Probe
True Airspeed (Textual)	✓	✓	Pitot / Static / OAT Probe
Density Altitude (Textual)	✓	✓	Pitot / Static / OAT Probe
<b>GPS Navigation / Waypoint Data</b>			
Textual Nav Data	✓	✓	GPS Navigator
Graphical Nav Data	✗	✓	GPS Navigator
<b>Heading Bug</b>			
Hdg Bug – Ref Only, no AP	✓	✓	None
<b>Audio and Visual Alerting</b>			
AoA Alerting	✓	✗	Pitot / Static
G Limit Alerting	✓	✗	None
Excessive Roll Alerting	✓	✗	None
<b>Misc.</b>			
Internal Battery Operation	✓	✓	Pitot / Static
Auto / Manual Brightness	✓	✓	None
tailBeaconX Control	✓	✓	tailBeaconX serial

Table 3 – Feature Matrix

### 7.2.1 Power Input (Required)

Power input is required and connects to the aircraft's power bus. Input range is compatible with both 12V and 24V aircraft. Internally, this power is diode OR'ed with the internal battery via a processor-controlled switch. This architecture allows the unit to continue operation if external power fluctuates or is completely lost.

Each AV-30-E must have a dedicated, properly labeled, pilot resettable circuit breaker as part of the installation. Power for the unit may be supplied from either the avionics bus or the main battery master relay.

### 7.2.2 Pitot and Static Interfaces (Required/Optional)

In addition to directly displayable data such as airspeed and altitude, pitot and static inputs are utilized within the probeless Angle of Attack algorithm and provide the underlying source for various air-data type data overlays (TAS & DALT).

When installed as a DG, pitot and static connections are not required unless TAS and DALT are desirable (also requires a dedicated OAT probe). See the detailed wiring diagram for more information.

### 7.2.3 Outside Air Temp Input (Optional)

The optional outside air temperature interface requires a dedicated external analog probe. This port connection is compatible with the Davtron P/N C307PS (not supplied).

This is a differential two-wire current source based on the Analog Devices AD590KH component and supplies a current that corresponds to the ambient temperature.



If two displays are connected to the same probe, the current will be split between the two and incorrect readings will be shown by both.

The sensor reading must be trimmed during the installation process to compensate for probe-to-probe variations.



The OAT probe is automatically detected by the system, and when detected, allows temperature related parameters to be selected for display by the pilot.

If the OAT probe is not detected, display of these parameters will automatically be inhibited.

#### **7.2.4 Audio Output (Optional)**

The optional audio panel connection is a low-voltage analog output that is designed to connect directly to an audio panel (typically a non-switched input). High power outputs capable of directly driving a cockpit speaker are not provided.

When installed as a DG, no audio alerting is supported, and this output should remain disconnected.



In non-metallic, IFR capable aircraft, this connection **MUST** remain disconnected due to lightning strike limitations.

#### **7.2.5 GPS Interface (Optional)**

The GPS interface is an optional RS-232 serial input that is compatible with the industry standard “Moving Map” output provided by most panel mounted GPS units, and NMEA serial interfaces provided by most hand-held GPS units.

This is a text/binary protocol output by the GPS navigator that contains situational awareness information such as ground speed, track, distance to destination, cross track, etc, and is typically utilized by remote mapping/display products to provide additional pilot awareness.

This output does not provide IFR compliant lateral or vertical guidance, therefore all deviation related data presented is for VFR operations only.

The AV-30-E does no computations or operations on the data obtained from the GPS navigator, and simply displays the received data in a textual or graphical format as configured by the pilot.



This serial interface may be connected in parallel between multiple AV-30 units and is supported in both the AI and DG modes.

The supported protocols are contained in Section 14- Serial Interface Specification.

### **7.2.6 tailBeaconX Control (optional)**

The AV-30-E has the option of being the transponder control interface for an installed tailBeaconX. This requires an RS-232 serial connection from the tailBeaconX to the AV-30-E. tailBeaconX can also act as your GPS source using the existing serial connection.

## **7.3 Internal Battery Operation**

### **7.3.1 General**

The internal battery consists of a rechargeable LiPo battery system with automatic recharge, self-test and power switching capability. The internal battery capacity will provide approximately 2 hours of operation at standard temperatures and 30 minutes (minimum) of operational capacity over the operational temperature range.

See the Internal Battery Operation section within the Pilots Guide for additional operational information.

## 8 Equipment Installation

### 8.1 Overview

Installation consists of the following steps:

- Remove / relocate any legacy instrumentation
- Add or locate an appropriate power source / breaker
- Wire power and systems interfaces as needed
- Mount the unit to the instrument panel with supplied screws
- Apply power and perform setup

### 8.2 Supplied Components

Component	Part Number	Description
AV-30-E Unit	UAV-1003429-001	AV-30-E Unit
AV-30-E Installation Kit	UAV-1004091-001	Installation Kit

*Table 4 – Supplied Components*

### 8.3 Non-Supplied Components

Component	Description
Pitot / Static Tubing	Length as required
Pitot Static T's	Quantity as required
Circuit Breakers (2A)	One required for each instrument
OAT Probe	Davtron P/N C307PS

*Table 5 – Non-Supplied Components*

# 8.4 Mechanical Drawing

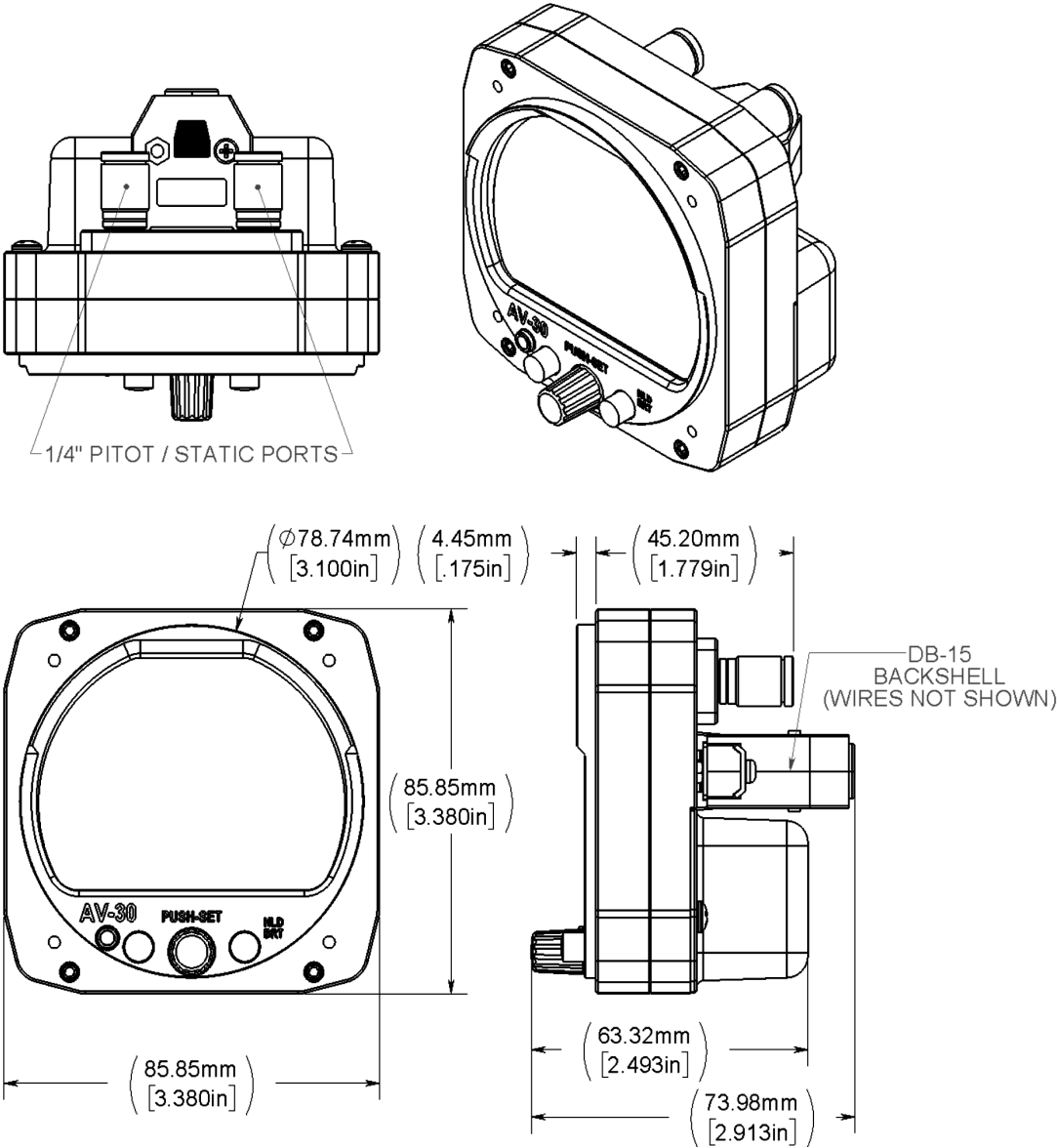



Figure 5 – Mechanical Drawing

## 8.5 Mounting Screw Length Restriction

The AV-30-E is fastened to the instrument panel with four 6-32 screws. The unit mounts from the rear of the instrument panel, with the screws being inserted from the front of the panel.

 The four 6-32 Mounting screws must observe depth limits given the internal component design.

 Torque screws to 6 (+/-1) Inch LBS.

The threaded hole in the AV-30-E bottoms out prior to the internal components. Installing a mounting screw that is longer than optimal will not damage the unit but will result in the unit not being fully fastened to the panel.

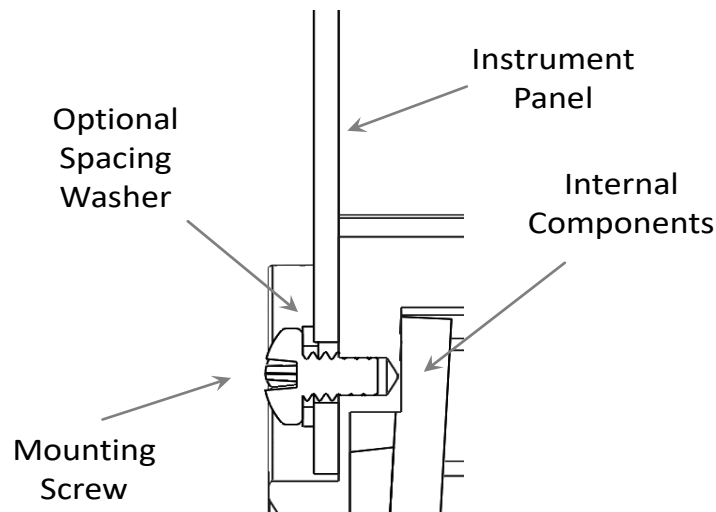

*Figure 6 – Mounting Screw Dept Limits*

The installation kit contains multiple length screws to assist in compensating for different instrument panel thicknesses.

## 8.6 Wiring Diagrams

The AV-30-E performs different functions when installed as an AI or DG, and therefore wiring varies based on installation. The following diagrams show connections for each configuration.

The primary differences are that the DG does not require pitot or static connections (if the associated feature set is not desired), and audio alerting is not supported.

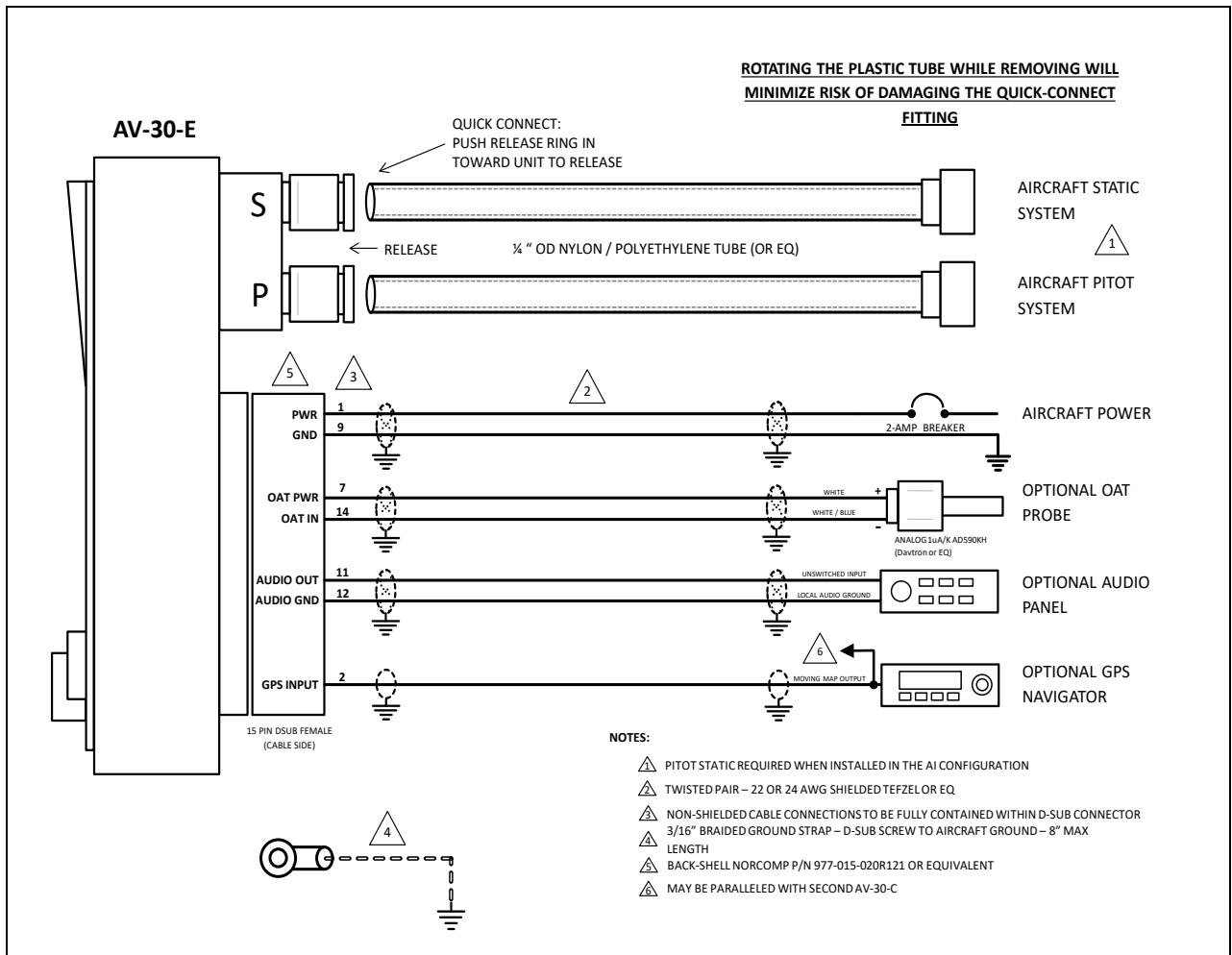

Figure 7 - Wiring Diagram – Attitude Indicator Position Installation

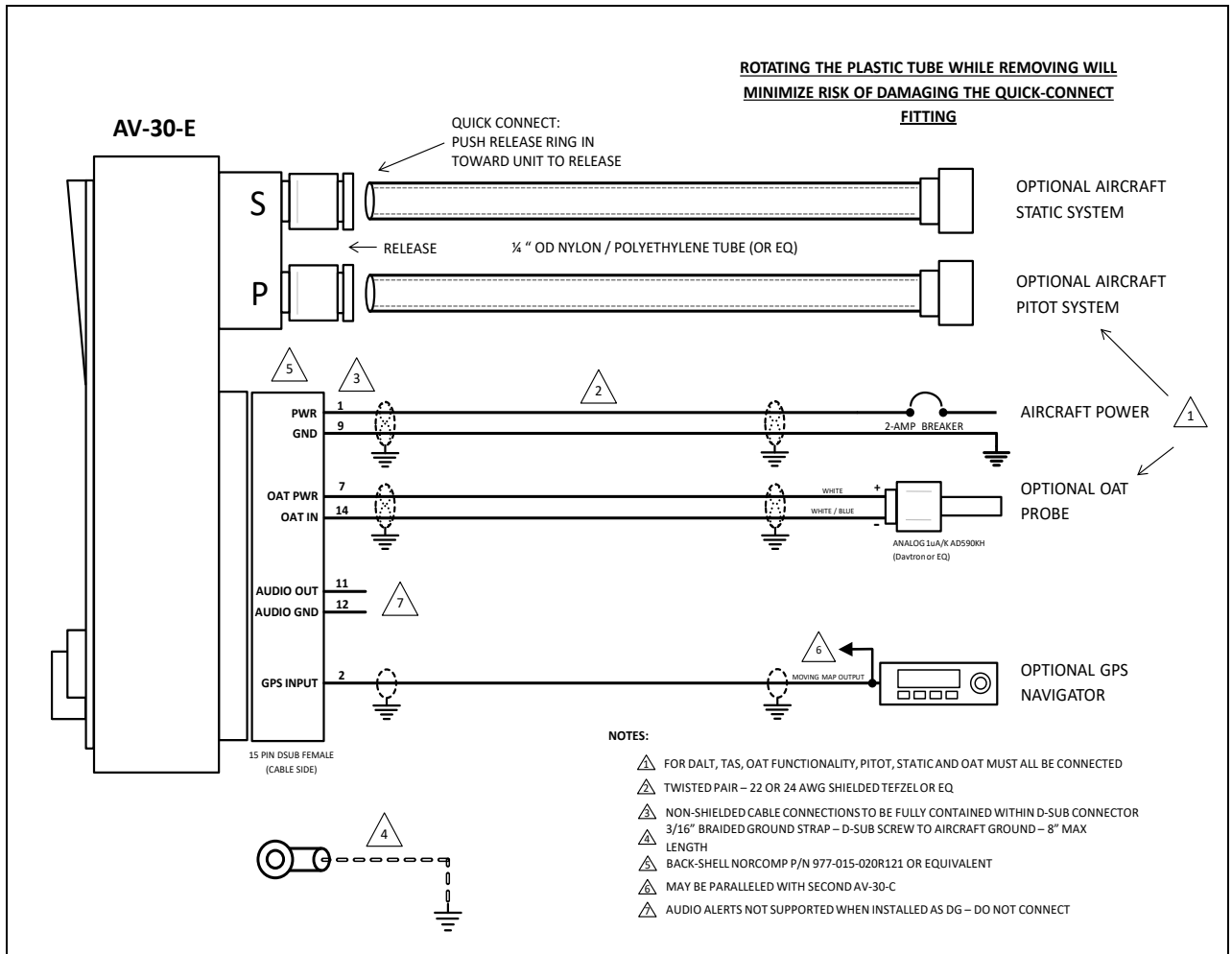

Figure 8 - Wiring Diagram – DG Position Installation

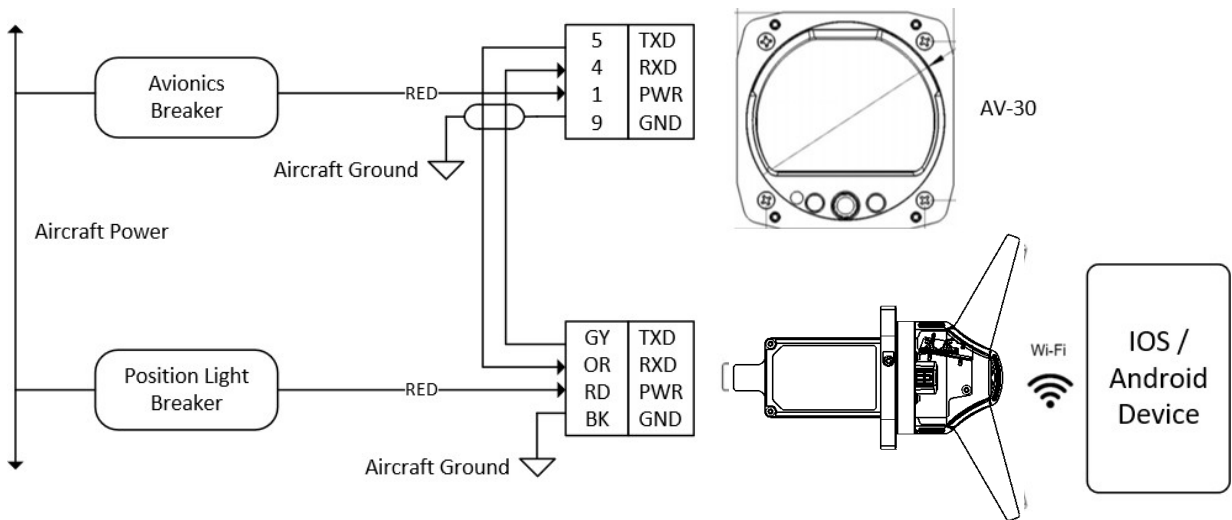

Figure 9 - Wiring Diagram - tailBeaconX Installation

## 8.7 Bonding Requirements

The following figure shows the grounding requirements for the electrical connections. The two D-Sub screws are to be utilized for shield and ground strap connections. The supplied ring terminal connectors are sized for these screws. The ground braid strap is to be less than 8 inches in overall length and at least 3/16 width. Alpha Wire part number 1230 SV001 or equivalent.



Figure 10 - Ground Braid Strap – 8" or Less in Length

The exposed (non-shielded) portions of the interface cables AND the ground drains are to remain less than 2.5 inches.

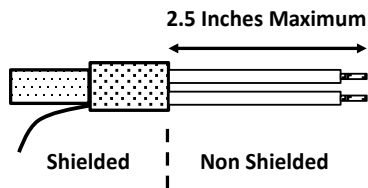

The bond between the unit (measured at the D-sub screws) to the aircraft frame must be 2.5 milli-Ohms or less

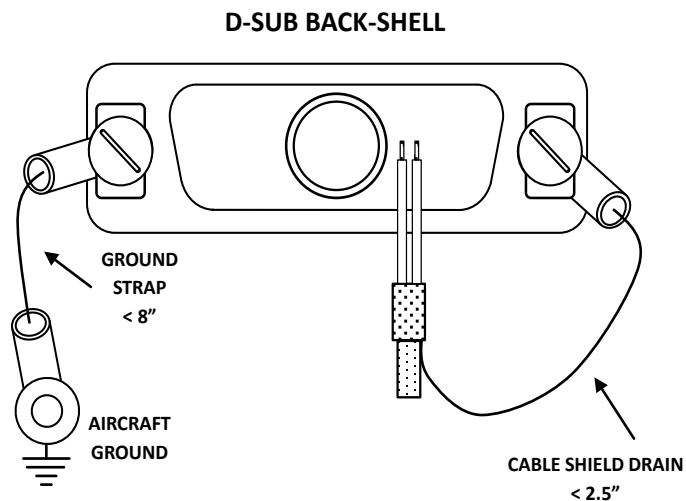

Figure 11 –Cable Shields and Ground Strap



## 8.8 Unit Pinout

Pin	Function	Type	Comment
1	Power	Power	+12 to +28 VDC
2	GPS Navigator	Input	GPS RS-232
3	Spare Serial	Output	Reserved - Do Not Connect
4	Serial 2	Input	TBX Grey Wire
5	Serial 2	Output	TBX Orange Wire
6	Spare Serial	Input	Reserved - Do Not Connect
7	OAT Supply	Output	White Probe Wire
8	Mfg Serial	Input	Reserved - Do Not Connect
9	Ground	Power	Aircraft Ground
10	Aux Power Ret	Power	Reserved - Do Not Connect
11	Audio H	Output	Audio Alerts
12	Audio L	Output	Audio Panel Ground
13	Aux Power Out	Power	Reserved - Do Not Connect
14	OAT Return	Input	White / Blue Probe Wire
15	Mfg Serial	Output	Reserved - DNC

Table 6 – Connector Pinout

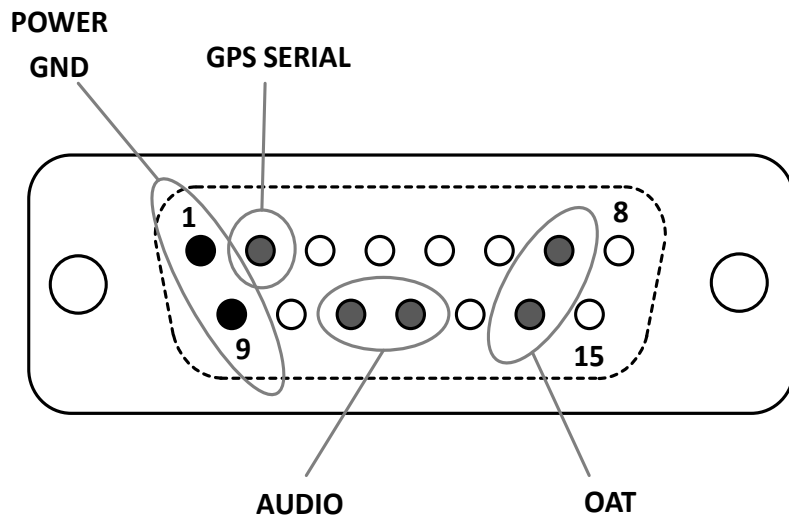

Figure 12 – Unit Connections – DB-15, Male (Rear Unit View)

## 9 Setup & Configuration

### 9.1 Startup and Common Controls

When powered on, the initial splash screen presents the company logo, unit model number, and the currently installed software version.



Figure 13 – Splash Screen

Operation in both AI and DG modes share common user interface controls as follows:

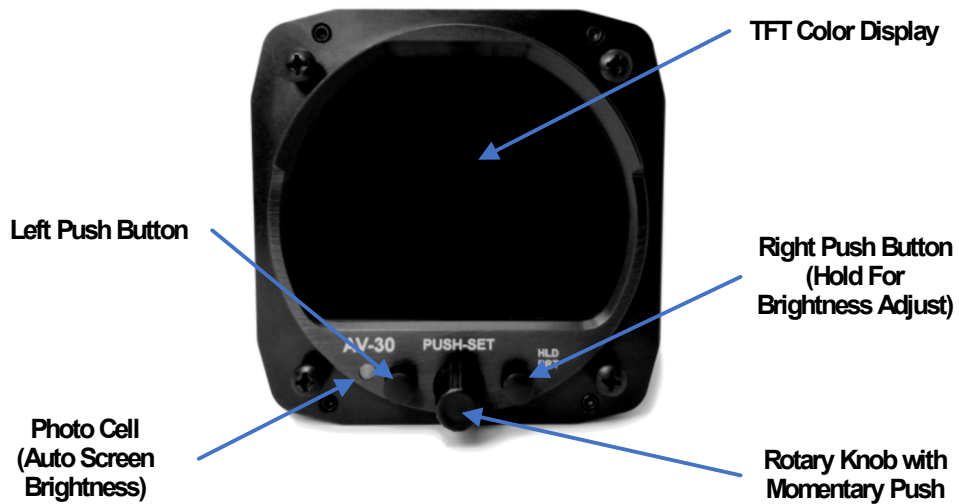

Figure 14 - Common User Interface Components

## 9.2 Available Menus

Setup and configuration menus are divided into three categories as follows:

- **Edit Fields Menu** (Pilot accessible)
- **Setup Menu** (Pilot Accessible)
- **Install Menu** (Non-Pilot Accessible)

The Edit Fields Menu allows the pilot to configure the display to show the various supplemental parameters in the desired locations. Details of this are covered in the associated pilots guide and not addressed here.

The Setup Menu allows the pilot to set various configurations and alerting limits as desired for the type of operations being performed.

The installer may wish to pre-configure some or all of these settings for the pilot, but the default settings are acceptable.



The Install Menu is for settings that are not normally required to be adjusted during flight. The installer must review and set these according to the installation configuration.

### 9.3 Install Menu Activation

To access the Install Menu, ensure the unit is turned off. Press and hold the main control knob in while power is applied.



**Push and Hold While Applying Power**

*Figure 15 – Installation Menu Access*

Keep the knob pressed until the startup logo has cleared. The Install Menu will now be enabled for access.

Press the Menu button until the INSTALL menu is shown:



*Figure 16 – Installation Menu Access*

Rotating the knob left and right will access the various parameters that may be configured. Pressing the knob when the desired field is shown will allow the associated setting to be adjusted. After adjustment,

pressing the knob again will disable the editing mode but the Install Menu will remain active.

Pressing DONE will exit the Setup Menu.

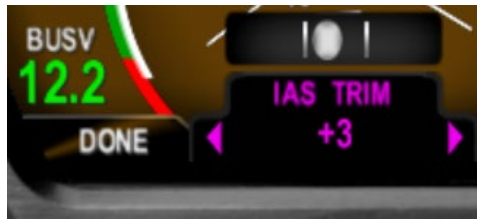

Figure 17 - Setup Done / Exit Option

## 9.4 Install Menu Settings

The Install Menu options and settings must be configured during the installation procedure:

Setting	Description	Options or Range
Unit Function	Unit Functionality	Set to default mode: AI or DG
Function Lock	Functionality Locked	If locked, pilot may not toggle function with knob press
Pitch Trim	Pitch Trim	Trim as needed: $\pm 20$ Degrees
Roll Trim	Roll Trim	Trim as needed: $\pm 5$ Degrees
Slip Trim	Slip Trim	Trim as needed: $\pm 5$ Degrees
OAT Trim	OAT Probe Trim	Trim as needed: $\pm 200$ (Unitless)
IAS Trim	IAS Trim	Trim as needed: $\pm 50$ (KTS or MPH)
ALT Trim	Baro Altitude Trim	Trim as needed: $\pm 500$ Feet
IAS Units	IAS Display Units	Set to match airspeed: KTS, MPH
VSpeed Limits	V <sub>so</sub> , V <sub>s1</sub> , V <sub>fe</sub> , V <sub>no</sub> , V <sub>ne</sub>	Set to match limits: 40 to 300 kts
Baro Units	Baro Setting Units	Set to match altimeter: HG, MB
Temp Units	OAT Units	Set as desired: C, F
GPS Nav Source	Serial Input	Se to match GPS type: NONE, AV1 9600, NMEA1 4800, NMEA1 9600, BEACON X
Serial 2	Aux Serial Input	Set to NONE
Demo Mode	Demo Mode	Set to DISABLED
Software Version	Software Version	For Reference
Software Checksum	Software Checksum	For Reference

Table 7 – Install Menu Options

## **9.5 Mandatory Settings**

The following settings are mandatory for each installation:

### **9.5.1 Unit Function**

Set to AI if installation is replacing an existing Attitude Indicator.

Set to DG if installation is replacing an existing Direction Indicator.

Set to either when installation is as a non-required instrument. In this mode, this setting is the initial default operating mode if the function lock below is not set to locked. Pilot may toggle mode.

### **9.5.2 Function Lock**

Enable function lock for primary AI and DG installations. This prevents the pilot from toggling the operating mode.

Installation on a non-required instrument may be lock or not locked, based on owner preferences. (Pressing and holding the knob when functionality is not locked will toggle between AI and DG modes.)

### **9.5.3 Trims**

Set Pitch, Roll and Slip Trim to accommodate any mounting errors.

Set IAS and Altitude Trims to match existing instrumentation as needed.

Trim the OAT values to match that of a secondary temperature source such as ATIS.

### **9.5.4 V-Speeds**

Set each of the V-Speeds to the values that correspond to the installation aircraft.

### **9.5.5 Display Units**

Set the IAS units to match that of the existing airspeed indicator.

Set the Baro units to match that of the existing altimeter.

Set OAT units to owner / pilot preference.

### 9.5.6 Serial Inputs

Set GPS Nav Source to the corresponding GPS navigator input type. Most handhelds are NMEA outputs while most panel mounted navigators are Aviation format. A tailBeaconX can also supply GPS input by selecting BEACON X. If no GPS is connected, set to NONE.

If connected to an Autopilot system using the APA Mini adapter, Set Serial 2 to APA Mini, if using the AV-30-E as a control head for a tailBeaconX Set Serial 2 to BeaconX, otherwise select NONE.

### 9.5.7 Demo Mode

Set Demo Mode to DISABLED

## 9.6 System Checkout

### 9.6.1 Alignment

During initial startup, the ALIGN flag should be presented and flash. This indicates internal sensor stabilization is occurring.

This should extinguish within 3 minutes, at which point valid attitude or direction indication is displayed.

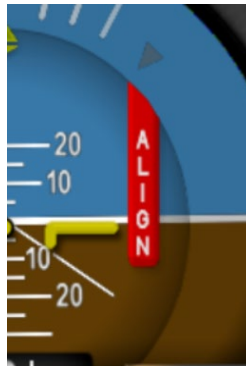

*Figure 18 - Align Flag*

If this is not observed, reference the trouble shooting section of this document for additional information.

### 9.6.2 OAT Interface

If an OAT probe is connected, utilize the display customization guidance provided in the Pilots Guide to configure the display to show OAT in at least one textual display field.



Figure 19 – OAT Indication

Note that OAT calibration is performed in the Setup procedures. This step only ensures that the OAT probe is detected properly.

### 9.6.3 GPS Navigator Interface

If a GPS Navigator is connected, utilize the display customization guidance provided in the Pilots Guide to configure the display to show GPS navigational data in at least one textual display field.

The image below shows a typical configuration that the pilot may setup.



Figure 20 – OAT Indication

On the GPS navigator, set a destination waypoint and initiate a direct-to sequence. Note that not all navigators will output serial data until a waypoint has been selected and navigation initiated.



## 9.6.4 tailBeaconX control Interface

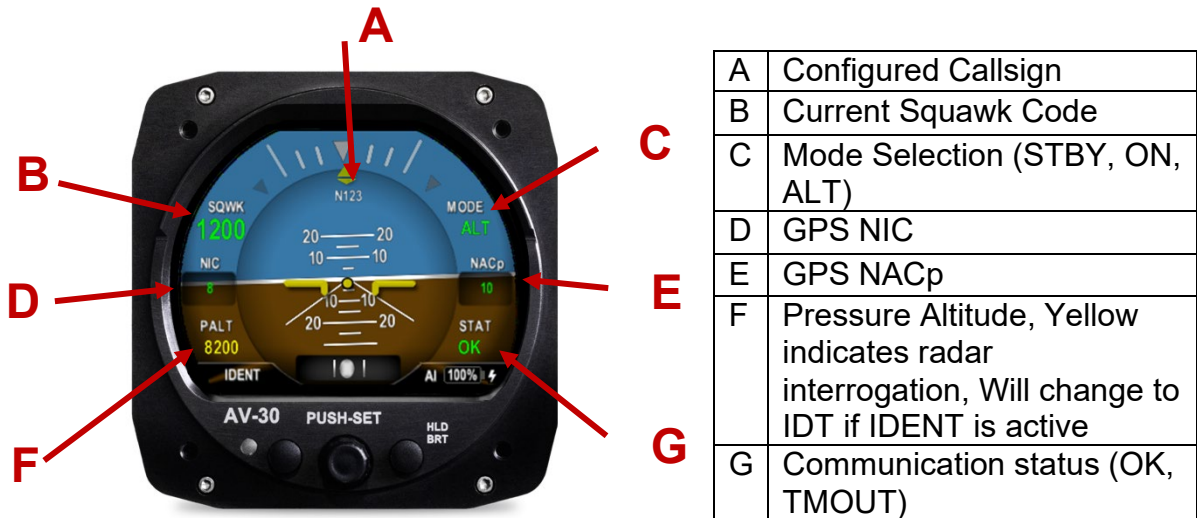

Figure 21 - tailBeaconX Control

### To Change Squawk

- Press in the center knob
- Navigate highlighted cursor to desired digit by rotating the knob
- Press in the center knob to select the desired digit
- Rotate the center knob to change the squawk digit
- Press in the center knob to accept the change
- Press the left button (*DONE*) to finish

### To Change Mode

- Press in the center knob
- Press the right button to cycle through each Mode selection (STBY, ON, ALT)
- Press the left button (*DONE*) to finish

### To Ident

- Press the left button

### Quick Squawk 1200

- Press in the center knob
- Press in the center knob to select a squawk digit
- Press the right button to quick squawk 1200
- Press the left button (*DONE*) to finish

# 10 Troubleshooting

The following steps are to aid in identifying installation or unit performance related issues:

Issue	Possible Resolution
<b>Power Related Issues</b>	
Unit does not power-on	Check associated breakers.
	Ensure aircraft battery is greater than 10VDC.
	Check wiring and pinouts.
Unit will not shut-off, even if power is removed	Ensure no pitot static blockage or line kinks are present (locking pressure and airspeed indication over 40 KTS).
<b>Stabilization Related Issues</b>	
Unit will not stabilize and aligning flag remains on	Return to factory for service if unit does not align within 3 minutes of power-on.
<b>Battery Related Issues</b>	
Battery indication shows fail	Contact factory.
<b>Trim Related Issues</b>	
Roll, Pitch or Slip show small but constant error	Set associated trim adjustment in Installation Menu.
Airspeed or Altitude shows small but constant error	Set associated trim adjustment in Installation Menu.
<b>Interface Related Issues</b>	
GPS information is expected but does not show up in data overlays.	Check GPS input is configured to match the connected GPS serial data type and speed.
	Set a direction indication to GPS TRK. If “No Data” is shown, check interface cables and pinouts. If “No GPS” is shown ensure protocols and speeds are set correctly.
<b>Alerts</b>	
Audio alerts are not being heard over the audio system	Check wiring and ensure alerts are enabled in the pilots Setup Menu.
	Ensure un-switched input is available on the audio panel.
	Verify volume setting is sufficiently high in the pilots Setup Menu.
Nuisance alerts are being generated	Ensure alerting limits are configured as desired in the Setup Menu.
	Disable any un-desired alerting features in the Setup Menu.

Table 8 – Trouble Shooting

## 11 Serial Interface Specification

GPS serial input is compatible with the “Aviation” and NMEA serial protocols. Aviation protocol is 9600 Baud, No Parity, 8 Data Bits, 1 Stop bit. NMEA is either 4800 or 9600 Baud, No Parity, 8 Data Bits, 1 Stop Bit.

The packets received are as follows:

Parameter Name	Aviation Packet	NMEA Packet
GPS Track	“C” Packet	\$GPRMC, Field 8
GPS Ground Speed	“D” Packet	\$GPRMC, Field 7
Distance to Waypoint	“E” Packet	\$GPRMB, Field 10
Cross Track Error	“G” Packet	\$GPRMB, Field 2
Desired Track	“I” Packet	Computed
Waypoint ID	“K” Packet	\$GPRMB, Field 5
Bearing to Waypoint	“L” Packet	\$GPRMB, Field 11
Magnetic Variation	“Q” Packet	\$GPRMC, Field 10
AT Master Flag	“T” Packet, Flag 4	\$GPGGA, Field 6
Garmin Master Flag	“S” Packet, Flag 5	N/A

*Table 9 - GPS Serial Specification*

# 12Field Update Capability

The unit software is field updateable and requires an in-line harness and Windows based PC. Contact the factory for additional information.

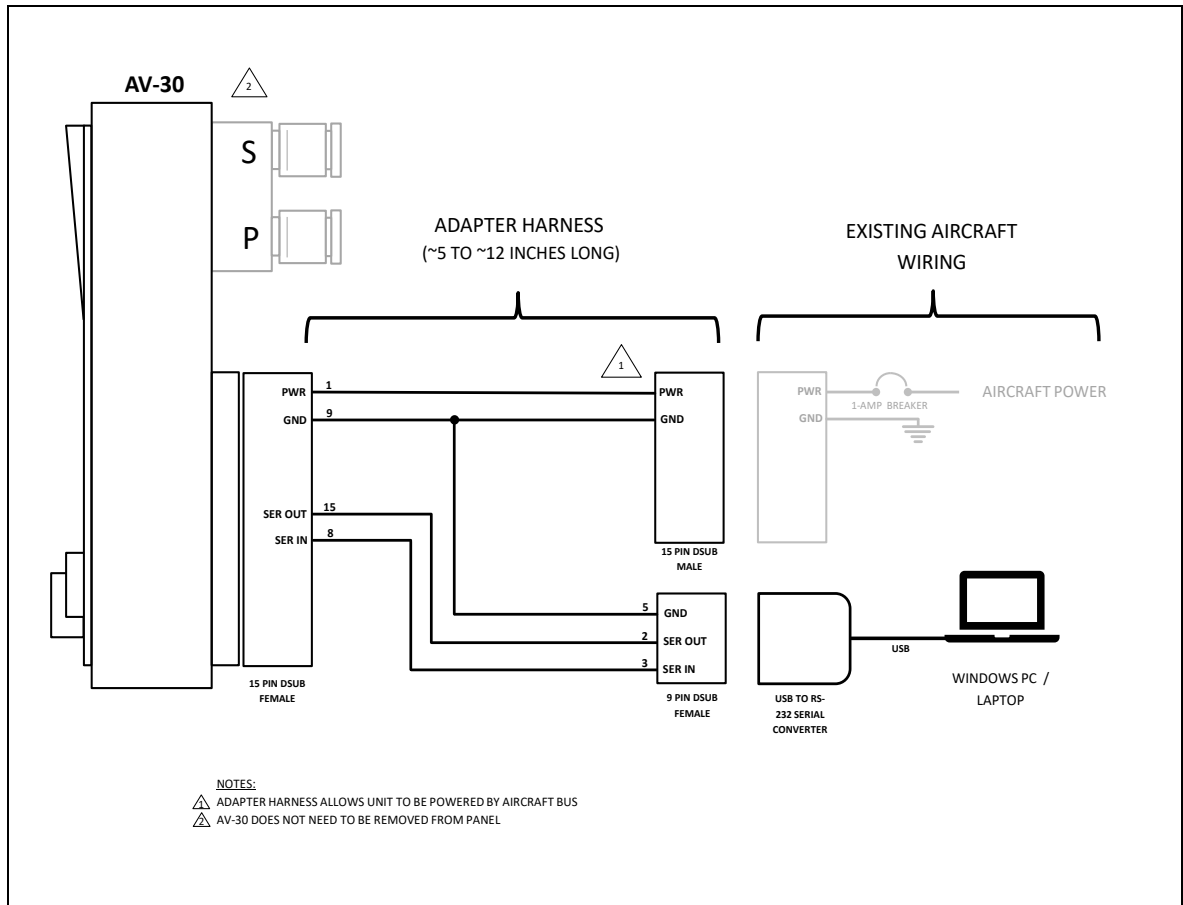

Figure 22 - Field Update Harness