



# SkyEcho

## Installation and Pilot's Guide



© 2022 uAvionix Corporation. All rights reserved.

Except as expressly provided herein, no part of this guide may be reproduced, transmitted, disseminated, downloaded or stored in any storage medium, for any purpose without the express written permission of uAvionix. uAvionix grants permissions to download a single copy of this guide onto an electronic storage medium to be viewed for personal use, provided that the complete text of this copyright notice is retained. Unauthorized commercial distribution of this manual or any revision hereto is strictly prohibited.

uAvionix® and Ping® are registered trademarks of uAvionix Corporation and may not be used without express permission of uAvionix.

SkyEcho and SkyEcho 2 are trademarks of uAvionix Corporation and may not be used without express permission of uAvionix.

Patent [uavionix.com/patents](https://uavionix.com/patents)

# 1 Revision History

Revision	Date	Comments
A	8/8/18	Pre-transmit release of SE2. ADS-B only
B	8/28/18	Mode C/S Bearingless Targets, DoCC Approval
C	9/11/18	User feedback corrections
D	12/24/18	FLARM Functionality
E	02/09/19	Regional Setting
F	05/21/19	Removal of Mode C/S Bearingless Targets
G	10/26/19	Firmware Update Procedures / Removal of FlarmBridge
H	12/12/19	Review for AIC publication
I	06/19/2020	Add Australian compliance, support link update, update for UK AIC use with transponders.
J	12/30/2020	Separation of SDA setting from Region Setting in configuration setup.
K	2/17/2021	Updated description of LED behavior
L	3/1/2021	Update per 25 February 2021 – SDA 1 default; EU CE/RED Declaration of Conformity
M	5/1/2022	Removal of country specific guidance to separate addendums
N	8/19/2022	Add charger guidance

## 2 Warnings / Disclaimers

The following required statement from the Federal Communications Commission (FCC) **applies to United States based entities with the exception of direct sales to the U.S. Government and units directly exported by uAvionix.**

*This device has not been authorized as required by the rules of the Federal Communications Commission. This device is not, and may not be offered for sale or lease, or sold or leased, until authorization is obtained.*

All device operational procedures must be learned on the ground.

Received traffic information is to be used as an aid to situational awareness and is merely supplemental and advisory in nature.

uAvionix is not liable for damages arising from the use or misuse of this product.

This equipment is classified by the United States Department of Commerce's Bureau of Industry and Security (BIS) as Export Control Classification Number (ECCN) 7A994.

These items are controlled by the U.S. Government and authorized for export only to the country of ultimate destination for use by the ultimate consignee or end-user(s) herein identified. They may not be resold, transferred, or otherwise disposed of, to any other country or to any person other than the authorized ultimate consignee or end-user(s), either in their original form or after being incorporated into other items, without first obtaining approval from the U.S. government or as otherwise authorized by U.S. law and regulations.

### 3 Limited Warranty

uAvionix SkyEcho products are warranted to be free from defects in material and workmanship for one year from purchase. For the duration of the warranty period, uAvionix, at its sole option, will repair or replace any product which fails in normal use. Such repairs or replacement will be made at no charge to the customer for parts or labor, provided that the customer shall be responsible for any transportation cost.

This warranty does not apply to cosmetic damage, consumable parts, damage caused by accident, dropping, abuse, misuse, water, fire or flood, damage caused by unauthorized servicing, or product that has been modified or altered.

IN NO EVENT SHALL UAVIONIX BE LIABLE FOR ANY INCIDENTAL, SPECIAL, INDIRECT OR CONSEQUENTIAL DAMAGES, WHETHER RESULTING FROM THE USE, MISUSE OR INABILITY TO USE THE PRODUCT OR FROM DEFECTS IN THE PRODUCT. SOME STATES DO NOT ALLOW THE EXCLUSION OF INCIDENTAL OR CONSEQUENTIAL DAMAGES, SO THE ABOVE LIMITATIONS MAY NOT APPLY TO YOU.

#### Warranty Service

Warranty repair service shall be provided directly by uAvionix.

## 4 Contents

1	Revision History.....	3
2	Warnings / Disclaimers .....	4
3	Limited Warranty.....	5
4	Contents .....	6
5	Introduction.....	9
5.1	International environments.....	10
5.1.1	Country Specific Addendums .....	10
5.1.2	United States of America .....	10
5.2	Features.....	10
5.3	Regulatory Compliance.....	12
5.3.1	Device Performance .....	12
5.3.2	Declaration of Conformity (DoC).....	12
6	Specifications .....	13
7	Limitations .....	14
7.1	Installation.....	14
7.1.1	Modifications and use outside of intended scope .....	15
7.1.2	Important Pilot Advisory Note Regarding Safety of Radio Frequency Energy .....	15
7.1.3	Proximity to other equipment.....	15
7.1.4	Altimeter Cross Check.....	15
7.1.5	Harmful Interference.....	15
7.1.6	Configurable Options.....	16
7.1.7	See and Avoid.....	16
7.1.8	Approvals .....	16
7.1.9	Usage Outside of Approved Locations .....	16
8	Equipment Installation and Configuration.....	17

8.1	Mounting.....	17
8.2	Connections.....	17
8.3	Installation Setup .....	19
8.3.1	Connecting to the SkyEcho2 via Wi-Fi.....	19
8.3.2	1090ES Transmit.....	21
8.3.3	Receiver Mode .....	22
8.3.4	Aircraft Address Programming (ICAO Address).....	22
8.3.5	Call Sign.....	23
8.3.6	FLARM ID .....	23
8.3.7	Ownship Filter ADS-B / FLARM.....	23
8.3.8	Emitter Category .....	23
8.3.9	VFR Squawk .....	25
8.3.10	ADS-B IN Capability .....	26
8.3.11	Air/Ground Threshold Speed VSO (knots).....	26
8.3.12	Aircraft Length and Width in Meters.....	26
8.3.13	GPS Antenna Offsets .....	27
8.3.14	System Design Assurance (SDA) .....	27
8.4	Update and Confirm Configuration.....	28
9	Normal Operation .....	28
9.1	Battery Pack / Charging .....	28
9.2	Power On/Off .....	28
9.3	Indicators .....	28
9.4	Electronic Flight Bag Application.....	29
9.5	Initial Use After Purchase.....	30
10	Firmware Update Procedure.....	31
10.1	Configuration Setup .....	31
10.1.1	Connecting to the SkyEcho via Wi-Fi.....	31

10.2 Update Transceiver Software.....33  
10.3 Wi-Fi Firmware .....35  
11 Contact uAvionix.....36



## 5 Introduction

The SkyEcho (SkyEcho 2) is a portable ADS-B transceiver. It incorporates the following into a single portable Electronic Conspicuity Device (ECD):

- 1090MHz ADS-B traffic receiver
- Secondary receiver which is selectable between 978 MHz UAT ADS-B or 868 MHz European FLARM
- 1090 MHz Class A0 transmitter limited to 20W.
- Precision SBAS GPS meeting the performance requirements of TSO-C199 Class B
- Barometer
- Wi-Fi support for interface to EFB applications and support function

SkyEcho meets the performance requirements of ECDs for multiple countries. Refer to country-specific addendums for applicability to local regulations.

## 5.1 International environments

### 5.1.1 Country Specific Addendums

EC devices are not approved for transmitting globally. At the time of publishing this revision, portable ADS-B OUT transmitters are permitted only in the UK, Australia, and New Zealand. Each approved country has an addendum to this Installation and Pilot's Guide which discusses local regulations. Please refer to the applicable addendum for country-specific instructions and limitations.

If operating SkyEcho outside of an approved location, the transmit function must be disabled using the configuration settings. SkyEcho can be used as a receiver globally.

### 5.1.2 United States of America

At the time of publishing of this revision, SkyEcho is not approved for use within the United States of America by either the Federal Communications Commission (FCC) or Federal Aviation Administration.

## 5.2 Features

The SkyEcho performs the following functions:

- 1090ES ADS-B 1090MHz reception
  - Receives ADS-B IN data from aircraft equipped with 1090 MHz Extended Squitter transmitters.
- 978MHz UAT reception (Selectable Option)
  - Receives ADS-B IN data from aircraft equipped with 978 MHz UAT transmitters. Receives Flight Information Services - Broadcast (FIS-B) and Traffic Information Services - Broadcast (TIS-B) compliant with UAT where available.
- FLARM® Receiver (Selectable Option)
  - Customers on the European Continent with participating Electronic Flight Bag (EFB) applications, have the option to choose FLARM reception capability. With this feature, the EFB

will present the location of FLARM equipped aircraft on the moving map. This option requires a FLARM license acquired through the EFB application used.

- For a list of compatible EFB's, visit

<https://uavionix.com/products/skyecho/>

- 1090ES transmission (1090 MHz)
  - Transmits ADS-B Out data on the 1090 MHz frequency.
  - Transmission may be enabled or disabled by configuration
- SBAS GPS reception
  - High precision SBAS GPS meeting performance requirements of TSO-C199, transmitting a Source Integrity Level (SIL) and System Design Assurance (SDA) values of 1, ensuring ATC and airborne avionics can receive and trust the GPS position being transmitted.
- Barometric Altimeter for pressure altitude
- Traffic correlation
  - Traffic information is correlated to provide a coherent view of nearby aircraft.
- GDL 90 format output (via Wi-Fi)
  - The following data is translated to standard GDL 90 format for Wi-Fi transmission to compatible situational display applications.
    - Traffic, ownship GPS, barometric pressure
    - FIS-B/TIS-B when received via UAT, where available
- Wi-Fi EFB connection
  - The GDL 90 data is transmitted over the built-in Wi-Fi interface for reception by standards compliant with EFB applications.
- Integrated rechargeable battery
  - The integrated rechargeable battery provides 12 hours of continuous use. The battery is recharged through USB-C connection, which can also provide power to SkyEcho directly when connected to a USB power source.

## 5.3 Regulatory Compliance

### 5.3.1 Device Performance

SkyEcho meets the Minimum Operational Performance Standards of DO-260B Class A0 with the output power limited to 20W and the SBAS GNSS receiver meets the performance requirements of TSO-C199.

### 5.3.2 Declaration of Conformity (DoC)

uAvionix Corporation declares that that the SkyEcho 2 ADS-B Transceiver conforms with the pertaining EU harmonization legislation and, since 31 January 2020, appropriate UK equivalents where applicable. Reference the following standards which are applied:

- EN 62368-1:2014
- EN 62311:2008
- EN 61000-4-2:2009
- EN 61000-4-3:2006/A1/A2
- EN 303 413 V1.1.1
- Final Draft EN 301 489-1 V2.2.2 & EN 301 489-19 V2.1.1
- EN 300 328 V2.1.1 & EN 301 489-17 V3.2.4

The Notified Body Telification B.V., with Notified Body number 0560 performed: applicable Modules B+C

Where applicable:

The issued EU-type examination certificate: 192140399/AA/01

Description of accessories and components, which allow the radio equipment to operate as intended and covered by the DoC: SkyEcho 2 to be used in conjunction with tablet running EFB APP like SkyDemon, EasyVFR, Foreflight Mobile, and others.

# 6 Specifications

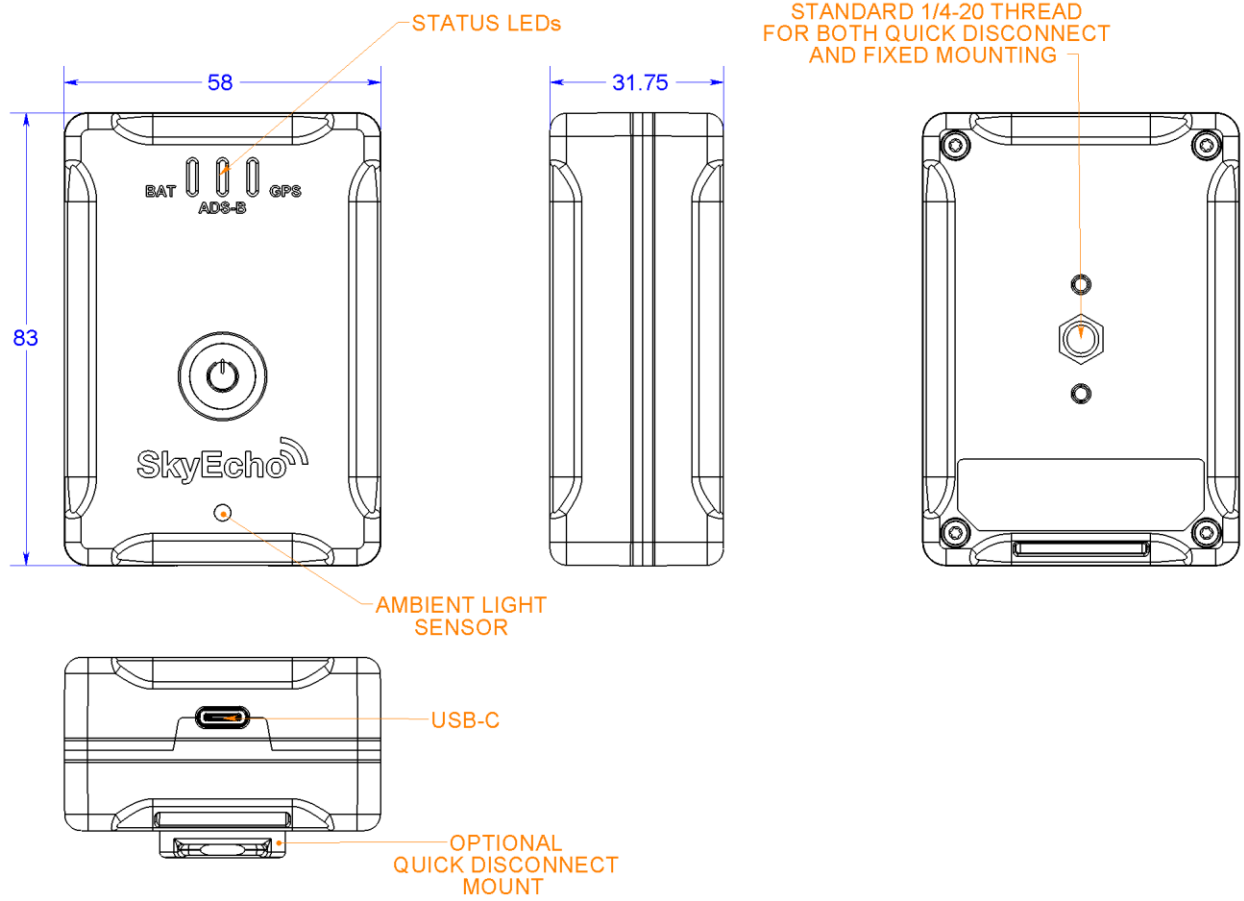

Specification	Value
Operating Time	12 hours
Size	57x82x30mm
Weight	200 grams
Source Integrity Level (SIL)	1
System Design Assurance (SDA)	1
Operating Temp	-45 to 70°C
Transmitter	
Frequency	1090MHz ±1MHz
Transmit Power	20W Nominal
Spectral Perf.	DO-260B DF-18
Receiver	
1090 Performance	-93 to 0dBm
978 Performance	-103 to 0dBm
WAAS GPS	
Augmentation	SBAS
Sensitivity	-167dBm
Altimeter	
Range	-1000 to 60,000ft
Interfaces	
Wi-Fi GDL 90 4 simultaneous connections	
802.11 b/g/n 2.4GHz	
USB-C	

## 7 Limitations

### 7.1 Installation

SkyEcho is a completely self-contained portable device with no required installation for external antenna, power source, or physical installation into the aircraft.

Transmission and reception performance are affected by antenna placement within the aircraft and is subject to airframe shadowing. Best performance is achieved when the SkyEcho is placed vertically orientated on the aircraft window mounted with the suction cup mount in a forward or side facing window with clear line of sight visibility in the direction of travel and clear visibility to the sky for GPS reception.

### **7.1.1 Modifications and use outside of intended scope**

This device has been designed and tested to conform to all applicable standards in the original form and when configured with the components shipped with the device. It is not permissible to modify the device, use the device for any use outside of the intended scope, or use the device with any antenna other than the one shipped with the device.

### **7.1.2 Important Pilot Advisory Note Regarding Safety of Radio Frequency Energy**

Safe use of this device requires care as to the placement of the internal antenna. Place the antenna at least 4cm away from any part of your body or that of other cabin occupants. To stop all RF emissions, remove power from the equipment or configure the equipment for receive mode only. Retain these instructions with your maintenance logs/files and for future reference.

### **7.1.3 Proximity to other equipment**

Mount the SkyEcho so that it does not compromise the operation of any other proximate communication or navigation antenna or system. It may be possible to hear transmissions through installed audio equipment, such as headsets.

### **7.1.4 Altimeter Cross Check**

The altitude reported by the EFB must be cross-checked against the aircraft's altimeter during pre-flight.

### **7.1.5 Harmful Interference**

It is the responsibility of the pilot to ensure that the transceiver causes no harmful interference to other onboard equipment and systems.

### **7.1.6 Configurable Options**

Accessing or altering configurable options not intended to be operated during flight by the pilot in command, as this may cause pilot distraction.

### **7.1.7 See and Avoid**

The SkyEcho is intended to enhance the pilot's ability to 'see and avoid'. Maneuvers to regain adequate separation should not be based on alerts issued by this device or connected applications alone.

### **7.1.8 Approvals**

Approvals do not cover adaptations to the aircraft necessary to accommodate ancillary equipment such as power provisions, mounting devices or external antennas, such items must still be approved under existing minor modification/change processes applicable to the aircraft.

**Warning: This transceiver is to be used to improve pilot situational awareness only and as a navigational aid. It is not intended for use in IFR flight conditions. uAvionix is not responsible for the transceiver's end use and will not be held liable for any events occurring from its use or misuse.**

### **7.1.9 Usage Outside of Approved Locations**

Transmit functionality is currently approved for use only in limited locations as evidenced by the presence of a country-specific addendum to the Installation and Pilot's Guide. If flying outside these locations, configure the device for receive functionality only or consult your local regulator for approval.



## 8 Equipment Installation and Configuration

This section describes the installation and configuration of the SkyEcho and related accessories in the aircraft, including mounting, wiring, and connections.

### 8.1 Mounting

SkyEcho is approved as a portable ECD. SkyEcho should be placed vertically orientated on an aircraft window with the optional suction cup mount with line of sight and visibility in the direction of travel and to the sky for the internal GPS. Installation location can significantly impact the receive and transmit range of the device.



### 8.2 Connections

1. Connect a USB-C cable to the USB-C port in order to provide direct power or to charge the battery. A blue LED will illuminate indicating external power is present. See notes in Section 8.2.1.

2. Care should be taken to make sure all devices are secure and will not interfere with pilot visibility, mobility, or aircraft operation.

### **8.2.1 Connection Notes**

It is important to choose an appropriate power supply and cable to ensure proper charging of SkyEcho.

1. It is recommended for fastest charging that the chosen USB power supply should be compliant with the Quick Charge 3 (QC3) standard. Use one which provides at least 18W. SkyEcho will not adequately charge at less than 2.5 amps.
2. SkyEcho has a high-capacity battery that will permit up to 12 hours of use. It is recommended that, where practical, charging is conducted at least monthly on the power supply until full.
3. Regardless of adapter output, it is not recommended that the SkyEcho be used permanently in-aircraft using a 12V USB adapter as the SkyEcho will consume more power than can be provided by the adapter.
4. While SkyEcho is fitted with a USB-C charging socket, it is not USB PD compliant. USB PD chargers will not properly handshake with and charge the SkyEcho. Instead, use only chargers equipped with USB-A output ports, and utilize the supplied USB-A to USB-C cable.
5. Computer USB ports (Mac or PC) cannot deliver sufficient power to charge a SkyEcho.

## 8.3 Installation Setup

Configuration of the SkyEcho is accomplished by logging on to the device directly from a computer or mobile device using the SkyEcho internal Wi-Fi hotspot. No additional application is necessary.

### 8.3.1 Connecting to the SkyEcho2 via Wi-Fi

1. To connect to the SkyEcho, power on SkyEcho and join a device to the wireless network SSID named SKYECHO-XXXX using the procedure for your device. This procedure is identical to joining any other public or private Wi-Fi on your chosen device.
2. *The No Internet Connection* message is normal when connected to SkyEcho.
3. Open any browser on your computer/mobile device that is connected to your SkyEcho via the Wi-Fi link and type in 192.168.4.1

The following landing page should load, depicting the SkyEcho status. Note the version numbers, SSID, and Current Status items may differ from the illustration.

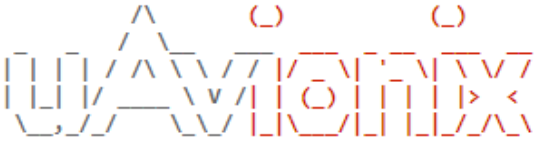

Wi-Fi Version: 0.2.30-SkyEcho [Update](#)  
ADS-B Version: 2.6.13 [Update](#)  
SSID: SkyEcho\_DB89  
Clients Connected: 1

[SkyEcho Setup](#)

[WiFi Settings](#)

#### Current Status

ICAO Address	7FFFFF
Callsign	CASATST4
GPS Fix	None
GPS Sats	0
Position	0, 0
GNSS Altitude	0 ft
Pressure Altitude	78 ft
NIC	0
NACp	0

Click on “[SkyEcho Setup](#)” to configure SkyEcho with your aircraft information.

A configuration page **similar to** the following should load:

**ADS-B Setup**

✓ Configuration loaded.

**Setup**

1090ES Transmit:	<input type="checkbox"/> Enable	Receiver Mode:	<input checked="" type="radio"/> UAT <input type="radio"/> FLARM (EU ONLY) <input checked="" type="radio"/> 1090ES
ICAO Address (hex):	<input type="text" value="7FFFFF"/>	Callsign:	<input type="text" value="CASATST4"/>
FLARM ID (hex):	<input type="text"/>	Owship Filter:	<input type="checkbox"/> Filter ADS-B <input type="checkbox"/> Filter FLARM
Emitter Category:	<input type="text" value="Light"/>	VFR Squawk:	<input type="text" value="1200"/>
ADS-B In Capability:	<input checked="" type="checkbox"/> 1090ES <input checked="" type="checkbox"/> UAT	V <sub>s0</sub> (knots):	<input type="text" value="0"/>
Aircraft Length:	<input type="text" value="L ≤ 15 m"/>	Aircraft Width:	<input type="text" value="W ≤ 23 m"/>
Lateral GPS Offset:	<input type="text" value="Center"/>	Longitudinal GPS Offset (m):	<input type="text" value="0"/>
SDA	<input type="text" value="0"/>		

[Main Page](#)

For proper operation the following parameters must be configured:

- 1090ES Transmit
- Receiver Mode
- ICAO Address (hex)
- Callsign
- If FLARM fitted: Enter FLARM ID (hex). Select FLARM filter
- If transmitting ADS-B: Select ADS-B Ownship filter
- Emitter Category
- VFR Squawk (country specific)
- ADS-B In Capability: Select 1090ES
- Air/Ground Threshold Speed (V<sub>s0</sub>)
- Aircraft Length
- Aircraft Width
- Lateral GPS Offset
- Longitudinal GPS Offset
- SDA

After configuration of your parameters click on “Apply” to save.

### 8.3.2 1090ES Transmit

This setting configures SkyEcho for transmission. Select the checkbox to enable transmission if allowed in your operating location.

Deselect the checkbox to disable transmission. Transmission must be deactivated when used on an aircraft with an Air Traffic Control Radar Beacon System (ATCRBS) Mode-S transponder which has ADS-B OUT enabled.

In certain countries, deactivation may be required based upon location or altitude. Refer to country-specific addendum.

### **8.3.3 Receiver Mode**

The SkyEcho contains dual receivers. The primary receiver is permanently configured for 1090MHz ADS-B. The secondary receiver can be configured for either 978MHz UAT ADS-B, or 868.4MHz FLARM® reception (European frequency only). Only one option can be selected.

When selecting UAT, SkyEcho will be able to receive 978MHz UAT ADS-B weather and traffic information if available.

When selecting FLARM, encrypted FLARM data is received and transmitted to the EFB application for processing. Specific FLARM functionality is dependent upon the EFB functionality implemented.

**Note, FLARM reception is only applicable in continental Europe and is not applicable in other regions owing to the use of country specific FLARM frequencies.**

### **8.3.4 Aircraft Address Programming (ICAO Address)**

The ICAO address is a 24-bit number issued to the aircraft by the registration authority of the aircraft. These addresses are usually written as a 6-digit hexadecimal number, although you may also encounter one written as an 8-digit octal number. The SkyEcho understands the hexadecimal format, so you must first convert an octal number to hexadecimal before entering. Sometimes this value is referred to as Mode S code. It is critical that the correct address is used. Incorrect addresses can disturb the service to other airspace users and may have regulatory compliance consequences.

### 8.3.5 Call Sign

CALL SIGN is a maximum 8-character code that corresponds to the tail number of the aircraft. (0-9, A-Z). The value should be entered without dashes (e.g. G-ABCD should be entered as GABCD).

### 8.3.6 FLARM ID

If you have a separate FLARM transmitting device in the aircraft, you can enter its allocated FLARM ID code here. This in conjunction with the Ownship Filter function (see next para) will stop your EFB self-alarms from your own FLARM transmission.

### 8.3.7 Ownship Filter ADS-B / FLARM

If you have either an Extended Squitter (ES) enabled Mode S transponder (aka ADS-B Out) fitted to your aircraft or you have enabled 1090ES transmit (ADS-B Out) on your SkyEcho 2, you can select ADS-B Ownship Filter to stop your EFB self-alarms or displaying a 'ghost' of your own aircraft. This requires that you also set the correct Mode S/ADS-B hex code for your aircraft. Similarly, if you have a FLARM transmitting device in your aircraft, you can filter out its transmissions to stop your EFB self-alarms or 'ghosting' based on this transmission. As with ADS-B, you must first set your FLARM ID code to enable this filter.

### 8.3.8 Emitter Category

To assist ATC tracking of aircraft, an aircraft category is transmitted. Select the aircraft category that most closely matches the aircraft.

Note EC devices are not approved for all emitter categories. Refer to country-specific addendum for local regulations.

Emitter Category can be set as follows:

Emitter Category	Description
Light Airplane	Any airplane with a maximum take-off weight less than 15,500

	pounds. This includes very light aircraft (light sport aircraft) that do not meet the requirements of US 14 CFR Section 103.1.
Small Airplane	Any airplane with a maximum take-off weight greater than or equal to 15,500 pounds but less than 75,000 pounds.
Large Airplane	Any airplane with a maximum take-off weight greater than or equal to 75,000 pounds but less than 300,000 pounds that does not qualify for the high vortex category.
Large Airplane with High Vortex	Any airplane with a maximum take-off weight greater than or equal to 75,000 pounds but less than 300,000 pounds that has been determined to generate a high wake vortex. Currently, the Boeing 757 is the only example.
Heavy Airplane	Any airplane with a maximum take-off weight greater than or equal to 300,000 pounds.
Highly Maneuverable Airplane	Any airplane, regardless of weight, which can maneuver in excess of 5 G's and maintain true airspeed above 400 knots.
Rotorcraft	Any rotorcraft regardless of weight.
Glider / Sailplane	Any glider or sailplane regardless of weight.
Lighter than Air	Any lighter than air (airship or balloon) regardless of weight.
Parachute	Any parachute / skydiver.
Ultralight Vehicle	A vehicle that meets the requirements of US 14 CFR Section 103.1. Light sport aircraft should not use the ultralight emitter



	category unless they meet US 14 CFR Section 103.1.
UAV	Any unmanned aerial vehicle or unmanned aircraft system regardless of weight
Space	Any spacecraft or trans-atmospheric vehicle.
Surface Vehicle - Emergency	Any ground vehicle in operation at an airport providing emergency services.
Surface Vehicle - Service	Any ground vehicle in operation at an airport NOT providing emergency services.
Point Obstacle	Point obstacle including tethered balloons.
Cluster Obstacle	Cluster obstacle.
Line Obstacle	Line obstacle.

### 8.3.9 VFR Squawk

The SkyEcho transmits a default squawk code. Enter the standard VFR squawk for your location.

Whilst the SkyEcho transmits a squawk code, note that this is in a different Downlink Format from your aircraft transponder and will be recognized by ATC as originating from an EC device; it cannot be interrogated.

Enter the standard VFR squawk code for your country in the SkyEcho 2 setup page. Set squawks as instructed by ATC on your aircraft's transponder during flight.

**There is no need to alter the squawk set in your SkyEcho which can remain on the VFR squawk. Note: You should not access setup pages in flight.**

### 8.3.10 ADS-B IN Capability

This selection is applicable for ground stations providing TIS-B functionality.

Any selection here is not applicable outside of the United States because TIS-B is not currently available. See 8.3.3 for receiver settings.

### 8.3.11 Air/Ground Threshold Speed VSO (knots)

This parameter allows the SkyEcho to automatically switch between airborne and ground modes. Enter the stall airspeed (in kts) of the aircraft in landing configuration. (0-999 knots).

### 8.3.12 Aircraft Length and Width in Meters

Note that air/ground behavior for ADS-B is established in accordance with RTCA DO-260B and is dependent upon the emitter category selected.

On the ground, ADS-B transmits encoded aircraft size information which is used by ATC to identify taxiing routes and potential conflicts. Enter the length and width (wingspan) (meters) fields and the appropriate size codes will be calculated for transmission.

Enter the Aircraft Length in Meters

$L \leq 15$	$55 < L \leq 65$
$15 < L \leq 25$	$65 < L \leq 75$
$25 < L \leq 35$	$75 < L \leq 85$
$35 < L \leq 45$	$L > 85$
$45 < L \leq 55$	

Enter the Aircraft Width (wing span) in Meters

$W \leq 72.5$
$72.5 < W \leq 80$

### 8.3.13 GPS Antenna Offsets

The GPS antenna offset is used in conjunction with the length and width to manage taxiway conflicts. A typical GPS does not report the geographic position of the center of the aircraft, or even the tip of the nose of the aircraft; instead, it usually reports the location of the actual GPS antenna (not the GPS receiver). In normal flight operation this distinction is of no importance at all, but if ADS-B is used to manage taxiway conflicts, a significant offset in antenna position could mean that the aircraft footprint is not in the same place as the ADS-B reported position. Although the GPS Antenna Offset is primarily intended for position correction on large transport aircraft, General Aviation aircraft can also have a significant offset. For example, if the aircraft has a long tail boom and the GPS antenna is on top of the tail, the GPS position could be 4 meters or more from the nose of the aircraft.

Enter the GPS Antenna Offset Lateral from Roll axis (Meters)

0	Right 2
Left 2	Right 4
Left 4	Right 6
Left 6	

Enter the GPS Antenna Offset Longitudinal from Aircraft nose (Meters)

0 to 60 Meters in 2 Meter increments

### 8.3.14 System Design Assurance (SDA)

The RTCA standards require SDA =1 before data can be presented to aircraft with certified ADS-B In systems. Sky Echo is capable of SDA 1 which is set by default.

## 8.4 Update and Confirm Configuration

1. After entering the correct information for all fields press Apply. You should receive a message confirming the configuration at the top of the screen.
2. Programming of the SkyEcho is complete. You can disconnect your computer or mobile device from the Wi-Fi hotspot.

## 9 Normal Operation

### 9.1 Battery Pack / Charging

The integrated battery pack needs to be fully charged before use.

Connect the USB-C cable to the connector on the bottom of the SkyEcho in order to charge the battery. The BLUE LED will remain lit during charging, and will extinguish when the battery is fully charged. Note: It can take up to 12 hours to completely recharge a fully discharged battery.

### 9.2 Power On/Off

Press and hold the momentary power switch for approximately 3 seconds to power the SkyEcho on.

Press and hold the momentary power switch for approximately 3 seconds to power the SkyEcho off.

### 9.3 Indicators

There are a 3 LEDs visible through the top cover of SkyEcho.

LED	Color	On
BAT	Blue	Battery Charging
BAT	Red	Battery Low (<33%)
BAT	Yellow	Battery 33%-66%
BAT	Green	Battery > 66%

<b>ADS-B</b>	Off	ADS-B receive only
<b>ADS-B</b>	Green (blinking)	ADS-B transmit/receive
<b>GPS</b>	Red	No GPS Lock
<b>GPS</b>	Yellow	2D GPS Lock
<b>GPS</b>	Green	3D GPS Lock

## 9.4 Electronic Flight Bag Application

Launch your GDL 90 compatible Electronic Flight Bag (EFB) application. Not all EFB applications support FLARM functionality.

Configure your EFB as necessary to access the device. Refer to your EFB instructions or EFB support team for configuration instructions.

Traffic and flight information should begin streaming to the application when in range.

Illustration: ForeFlight, SkyDemon, EasyVFR and OzRunways displaying ADS-B traffic and weather from SkyEcho is shown below.



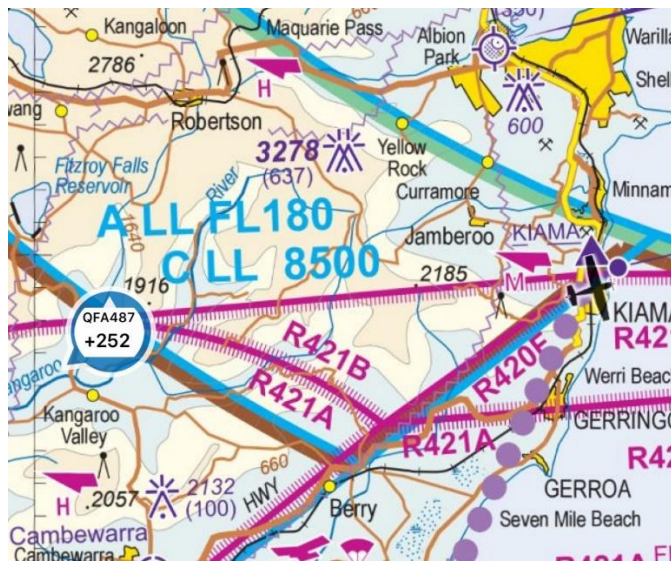
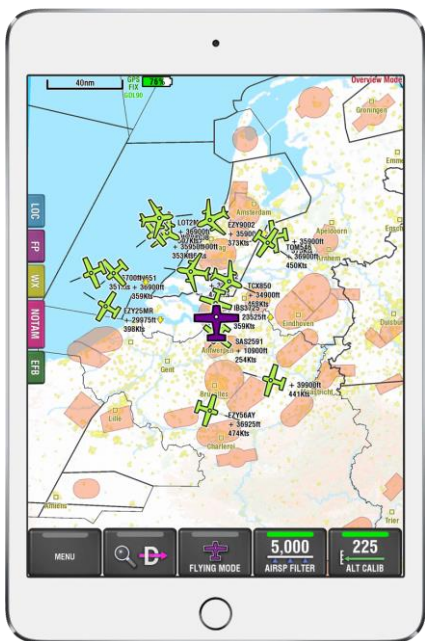

Altitude must be pre-flight cross-checked by comparing the aircraft's altimeter with the GPS altitude displayed on the EFB application.

## 9.5 Initial Use After Purchase

Having set up your Sky Echo in accordance with the instructions above, before flying it for the first time you will need to achieve an initial GPS fix in your location. This first fix will take much longer than in subsequent use as the Sky Echo needs to update its satellite Almanac to determine which are 'in-view' at your location. Having built an Almanac the Sky Echo can disregard satellites that will be over the horizon and fix rapidly thereafter.

To achieve this first GPS fix, place your Sky Echo in an outdoor location with a clear view of the sky above it. Whilst it can achieve a fix if affixed to a window, this cannot be assured inside a building. Please be patient and allow the fix to complete; a change of hemisphere from the Sky Echo's point of manufacture could require up to an hour for it to rebuild its Almanac.

When the Almanac update is complete the GPS LED will turn from red to green. If it does not, make sure that the Sky Echo has a clear view of the sky and is not overshadowed by tall buildings. An airfield is an ideal location for the first fix, but allow enough time. Subsequent fixes will be achieved in minutes.

## 10 Firmware Update Procedure

### 10.1 Configuration Setup

Configuration of the SkyEcho is accomplished by logging on to the device directly from a computer or mobile device using the SkyEcho internal Wi-Fi hotspot. No additional application is necessary.

The following are procedures for updating the SkyEcho firmware. You may be provided with one or two files to update, corresponding to the procedures below. The most recent firmware is always posted at [www.uavionix.com/support](http://www.uavionix.com/support).

- Save the provided firmware file(s) to an accessible location on your computer/tablet prior to joining the SkyEcho Wi-Fi hotspot.

#### 10.1.1 Connecting to the SkyEcho via Wi-Fi

1. To connect to the SkyEcho, power on SkyEcho and join a device to the wireless network SSID named SKYECHO-XXXX using the procedure for your device. This procedure is identical to joining any other public or private Wi-Fi on your chosen device.

2. *The No Internet Connection* message is normal when connected to SkyEcho.

3. Open any browser on your computer/mobile device that is connected to your SkyEcho via the Wi-Fi link and type in 192.168.4.1

The following landing page should load:

This page will show the SkyEcho status. Actual values may differ from the illustration below.

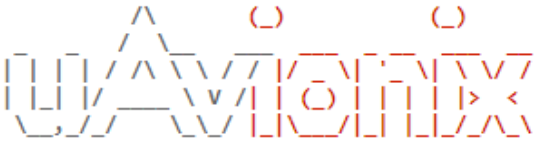

Wi-Fi Version: 0.2.30-SkyEcho [Update](#)  
ADS-B Version: 2.6.13 [Update](#)  
SSID: SkyEcho\_DB89  
Clients Connected: 1

[SkyEcho Setup](#)  
[WiFi Settings](#)

#### Current Status

ICAO Address	7FFFFF
Callsign	CASATST4
GPS Fix	None
GPS Sats	0
Position	0, 0
GNSS Altitude	0 ft
Pressure Altitude	78 ft
NIC	0
NACp	0



## 10.2 Update Transceiver Software

Follow this procedure if you were given a Transceiver Software (\*.uav ) update file.

1. Click on the “ADS-B Version” Update Link:



2. Click on “Choose File”, navigate to the Transceiver Software firmware file (.uav), and click “Update.”

### Ping Update



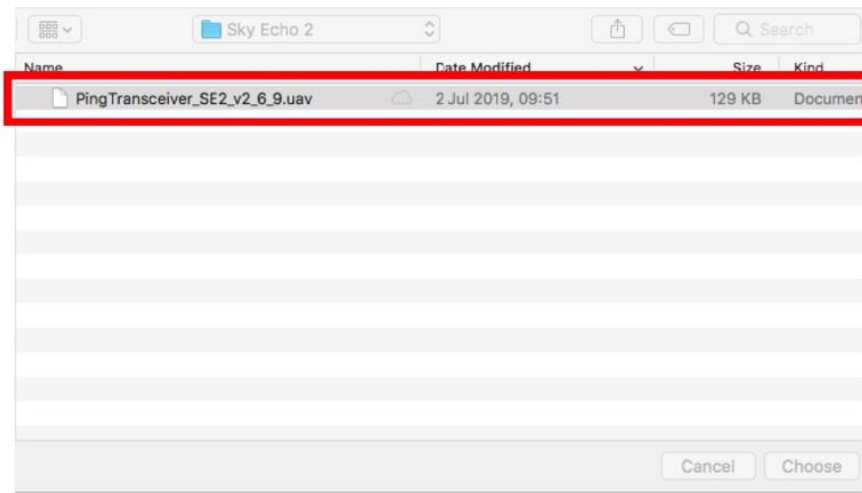
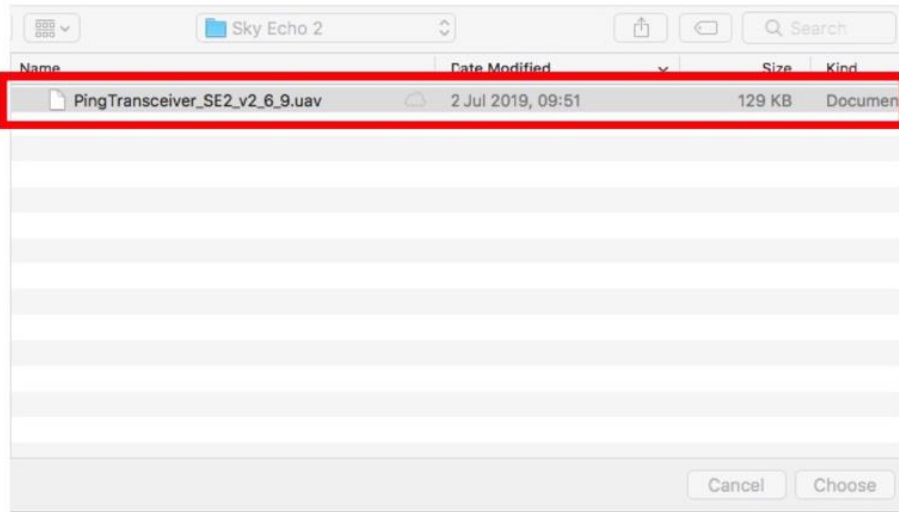

## Ping Update



3. The system will update. You will see the following screen for a few seconds.

## Update Ping ADS-B

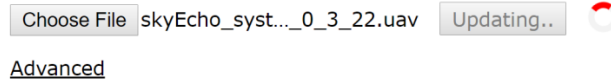

4. When complete, the following screen will appear:

**Update success, device 1 restarting**

[Return to status page](#)

5. Manually power off, then power back on SkyEcho to reboot.

## 10.3 Wi-Fi Firmware

Follow these instructions if you were given Wi-Fi update firmware (\*.bin).

1. **Reconnect to the SkyEcho hotspot as described above.**
2. Open a web browser and navigate to 192.168.4.1
3. Click on the “Wi-Fi Version” Update Link:



4. Click on “Choose File”, navigate to the Wi-Fi firmware file (.bin), and click “Update.”

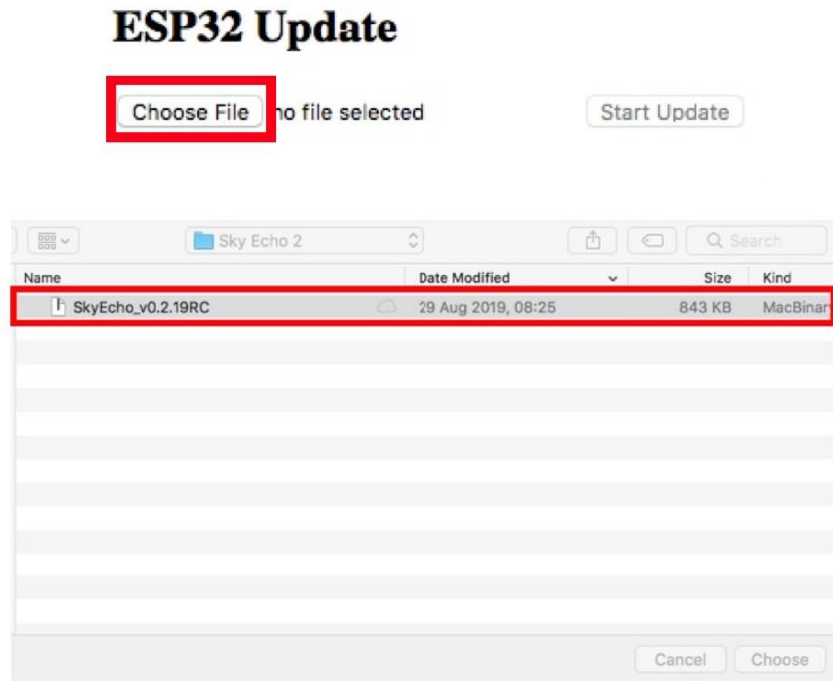

5. The system will update.
6. When complete, go back to the main page to confirm both ADS-B and Wi-Fi versions match the files delivered.
7. Reboot the SkyEcho by manually turning power off, then back on.

## 11 Contact uAvionix

For additional questions or support please visit <http://uavionix.com/support>